



ALLOY CASTING

Aluminum

Toll Free (800) 527-1318
(972) 286-2368
Fax (972) 557-4727

BALL FINIALS

DOUBLE FACE ∅



PIECE HAS A FLAT BASE 1 1/8" DIA
BALL IS 1 1/4" DIA

8001

HEIGHT	1 7/8"
WIDTH:	1 1/4"
THICK:	1 1/4"
WEIGHT:	0.2 lbs

DOUBLE FACE 3/4" ■



BALL IS 13/16" DIA
TUBE SEAT IS 1" SQ.
STUB IS 9/16 SQ AND 3/4" LONG

8003

HEIGHT	1 7/8"
WIDTH:	3/4"
THICK:	3/4"
WEIGHT:	.06 lbs

DOUBLE FACE 1" ■



BALL IS 1" DIA.
TUBE SEAT IS 15/16" SQ.
STUB IS 7/8" SQ. AND 5/8" LONG

7717

HEIGHT	2 3/8"
WIDTH:	1 1/4"
THICK:	1 1/4"
WEIGHT:	0.2 lbs

NEW

DOUBLE FACE 1 1/2" ■



BALL IS 1 5/8" DIA
SET IS 1 5/8" IN SQ.
STUB IS 1 1/8" SQ BY 1" LONG

7792

HEIGHT	3 1/2"
WIDTH:	1 5/8"
THICK:	1 5/8"
WEIGHT:	0.5 lbs

DOUBLE FACE 1 1/2" ■



BALL IS 1 1/2" DIA
TUBE SEAT IS 1 5/8" SQ.
STUB IS 1 1/4 SQ AND 1/2" LONG

7759

HEIGHT	2 5/8"
WIDTH:	1 5/8"
THICK:	1 5/8"
WEIGHT:	0.4 lbs

DOUBLE FACE 1 1/2" ■



BALL IS 1" DIA
TUBE SEAT IS 1 1/2" SQ.
STUB IS 1 3/8 SQ AND 1/2" LONG

1409

HEIGHT	2 3/4"
WIDTH:	1 1/2"
THICK:	1 1/2"
WEIGHT:	0.2 lbs

DOUBLE FACE 2" ■



BALL IS 2" DIA
TUBE SEAT IS 2 1/4" SQ.
STUB IS 1 7/8 SQ AND 1" LONG

8005

HEIGHT	4"
WIDTH:	2 1/4"
THICK:	2 1/4"
WEIGHT:	1.0 lbs

NEW

DOUBLE FACE



BALL IS 1 3/4" DIA
TUBE SEAT IS 1 1/8" SQ.
STUB IS 5/8 SQ AND 3/4" LONG

8057

HEIGHT	3 1/4"
WIDTH:	1 3/4"
THICK:	1 3/4"
WEIGHT:	0.4 lbs

NEW

∅



BALL IS 1 17/8" DIA
BASE IS 1 1/2" DIA

8054

HEIGHT	2 7/8"
WIDTH:	1 7/8"
THICK:	1 7/8"
WEIGHT:	0.4 lbs

NEW

∅



BALL IS 2 1/2" IN DIA.
BASE IS 1 1/2" IN DIA.

8055

HEIGHT	2 3/4"
WIDTH:	2 1/8"
THICK:	2 1/8"
WEIGHT:	0.6 lbs

NEW

∅



BALL IS 2 1/4" IN DIA.

8040

HEIGHT:	2 3/4"
WIDTH:	2 1/4"
THICK:	2 1/4"
WEIGHT:	0.6 lbs

NEW



BALL IS 1 3/8" IN DIA
STUB 1/2" DIA. X 3/8" LONG

9072

HEIGHT	3 3/4"
WIDTH:	2 1/4"
THICK:	2 1/4"
WEIGHT:	0.4 lbs

Toll Free (800) 527-1318

(972) 286-2368

Fax: (972) 557-4727



ALUMINUM CASTINGS

10" BALL AND BASE

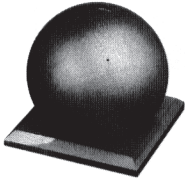

1710

HEIGHT:	
WIDTH:	
THICK:	
WEIGHT:	18.8 lbs 47.75 kgs

BASE FOR 10" BALL

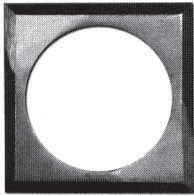

1711

HEIGHT:	10 3/8" 26.35 cm
WIDTH:	10 3/8" 26.35 cm
THICK:	1" 2.54 cm
WEIGHT:	3.0 lbs 7.62 kgs

10" BALL

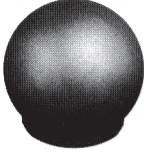

1712

HEIGHT:	8 1/2" 21.59 cm
WIDTH:	10" DIA 25.4 cm
THICK:	1/2" wall 1.27 cm
WEIGHT:	15.8 lbs 40.13 kgs

STAMPED ALUMINUM LEAVES 1/16" FLAT



DOUBLE FACED

NOT AVAILABLE

1271

HEIGHT:	5 1/2" 13.97 cm
WIDTH:	3" 7.62 cm
THICK:	1/16" 0.16 cm

STAMPED ALUMINUM LEAVES 1/16" FLAT



DOUBLE FACED

NOT AVAILABLE

1272

HEIGHT:	5 1/2" 13.97 cm
WIDTH:	3" 7.62 cm
THICK:	1/16" 0.16 cm

6" BALL AND BASE

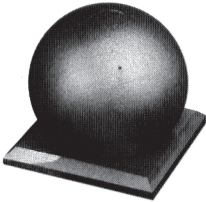

1760

HEIGHT:	
WIDTH:	
THICK:	
WEIGHT:	5.8 lbs 14.73 kgs

BASE FOR 6" BALL

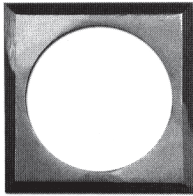

1761

HEIGHT:	6" 15.24 cm
WIDTH:	6" 15.24 cm
THICK:	5/8" 0.63 cm
WEIGHT:	1.0 lbs 2.54 kgs

6" BALL

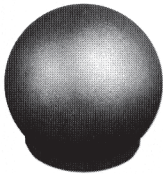

1762

HEIGHT:	4 1/2" 11.43 cm
WIDTH:	6" DIA 15.24 cm
THICK:	1/2" wall 1.27 cm
WEIGHT:	4.8 lbs 12.19 kgs

STAMPED ALUMINUM LEAVES 1/16" FLAT



DOUBLE FACED

NOT AVAILABLE

1276

HEIGHT:	9" 22.86 cm
WIDTH:	2 7/8" 7.30 cm
THICK:	1/16" 0.16 cm

STAMPED ALUMINUM LEAVES 1/16" CURVED 1/2" HIGH



DOUBLE FACED

NOT AVAILABLE

1274

HEIGHT:	9" 22.86 cm
WIDTH:	2 5/8" 6.67 cm
THICK:	1/16" 0.16 cm



5/8" ϕ STUB

2779

HEIGHT:	6" 15.24 cm
WIDTH:	2.5" 6.35 cm
THICK:	1.0" 2.54 cm
WEIGHT:	0.3 lbs 0.76 kgs



3/4" ϕ STUB

2777

HEIGHT:	5.38" 13.67 cm
WIDTH:	2.75" 6.99 cm
THICK:	0.88" 2.24 cm
WEIGHT:	0.3 lbs 0.76 kgs

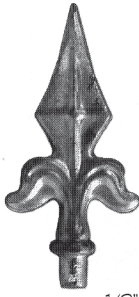

1/2" ϕ STUB

2776

HEIGHT:	4.38" 11.13 cm
WIDTH:	2.25" 5.72 cm
THICK:	0.75" 1.91 cm
WEIGHT:	0.15 lbs 0.38 kgs

STAMPED ALUMINUM LEAVES 1/16" FLAT



DOUBLE FACED

NOT AVAILABLE

1275

HEIGHT:	9 1/2" 24.13 cm
WIDTH:	3 1/2" 8.89 cm
THICK:	1/16" 0.16 cm

STAMPED ALUMINUM LEAVES 1/16" FLAT



DOUBLE FACED

NOT AVAILABLE

1278

HEIGHT:	4 3/4" 12.07 cm
WIDTH:	4" 10.16 cm
THICK:	1/16" 0.16 cm

Revision Date: 05/01/99

BALL FINIALS

Toll Free (800) 527-1318
 (972) 286-2368
 Fax (972) 557-4727

ALLOY CASTING

Aluminum



NEW

DOUBLE FACE \emptyset



PIECE HAS A BASE 2 7/8 " DIA
 BALL IS 3 " DIA

8033

HEIGHT 3 3/4"
 WIDTH: 3"
 THICK: 3"
 WEIGHT: 1.8

NEW

DOUBLE FACE \emptyset



PIECE HAS A BASE 1 1/2 " DIA
 BALL IS 2 1/4 " DIA

8075

HEIGHT 2 3/4"
 WIDTH: 2 1/4"
 THICK: 2 1/4"
 WEIGHT: 0.6

HEIGHT
 WIDTH:
 THICK:
 WEIGHT:

HEIGHT
 WIDTH:
 THICK:
 WEIGHT:

HEIGHT
 WIDTH:
 THICK:
 WEIGHT:

HEIGHT
 WIDTH:
 THICK:
 WEIGHT:

HEIGHT
 WIDTH:
 THICK:
 WEIGHT:

HEIGHT
 WIDTH:
 THICK:
 WEIGHT:

HEIGHT
 WIDTH:
 THICK:
 WEIGHT:

HEIGHT
 WIDTH:
 THICK:
 WEIGHT:

HEIGHT
 WIDTH:
 THICK:
 WEIGHT:

HEIGHT
 WIDTH:
 THICK:
 WEIGHT: